

HF41F

SUBMINIATURE POWER RELAY



File No.: E133481



File No.: 40020043



File No.: CQC17002175722

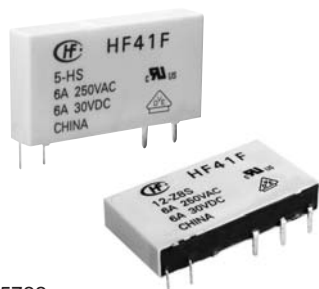

Features

- Slim size (width 5mm)
- High breakdown voltage 4kV (between coil and contacts)
- Surge voltage up to 6kV (between coil and contacts)
- Meeting VDE 0700, 0631 reinforce insulation
- High sensitive: Approx.170mW
- Sockets available
- 1 Form A and 1 Form C configurations
- Environmental friendly product (RoHS compliant)
- Outline Dimensions: 28.0mm x 5.0mm x 15.0mm

CONTACT DATA

Contact arrangement	1A, 1C
Contact resistance ¹⁾	No gold plated:100mΩ max. (at 1A 6VDC) Gold plated: 30mΩ max. (at 1A 6VDC)
Contact material	AgSnO ₂ , AgNi
Contact rating (Res. load)	6A 250VAC / 30VDC
Max. switching voltage	400VAC / 125VDC
Max. switching current	6A
Max. switching power	1500VA / 180W
Mechanical endurance	1 x 10 ⁷ ops
Electrical endurance	H type: 6 x 10 ⁴ ops (6A 250VAC/30VDC, Resistive load, AgNi, at 85°C, 1s on 9s off) Z type: 3 x 10 ⁴ ops (NO, 6A 250VAC/30VDC, Resistive load, AgNi, at 85°C, 1s on 9s off) 1 x 10 ⁴ ops (NC, 6A 250VAC/30VDC, Resistive load, AgNi, at 85°C, 1s on 9s off)

Notes:1) The data shown above are initial values.

CHARACTERISTICS

Insulation resistance	1000MΩ (at 500VDC)	
Dielectric strength	Between coil & contacts	4000VAC 1 min
	Between open contacts	1000VAC 1 min
Operate time (at nomi.volt.)	8ms max.	
Release time (at nomi.volt.)	4ms max.	
Shock resistance ¹⁾	Functional	49m/s ²
	Destructive	980m/s ²
Vibration resistance ¹⁾	10Hz to 55Hz 1mm DA	
Humidity	5% to 85% RH	
Ambient temperature	-40°C to 85°C	
Termination	PCB	
Unit weight	Approx. 5g	
Construction	Plastic sealed, Flux proofed	

- Notes: 1) Index is that of relay without socket.
 2) The data shown above are initial values.
 3) Please find coil temperature curve in the characteristic curves below.
 4) Please do not install a SPDT(1 Form C) type relay on either of the smallest sides or facing downward.
 5) UL insulation system: Class A.

COIL

Coil power	5VDC to 24VDC: Approx. 170mW 48VDC, 60VDC: Approx. 210mW
------------	---

COIL DATA

at 23°C

Nominal Voltage VDC	Pick-up Voltage VDC max. ²⁾	Drop-out Voltage VDC min. ²⁾	Max. Voltage VDC ³⁾	Coil Resistance Ω
5	3.75	0.25	7.5	147 x (1±10%)
6	4.50	0.30	9.0	212 x (1±10%)
9	6.75	0.45	13.5	476 x (1±10%)
12	9.00	0.60	18	848 x (1±10%)
18	13.5	0.90	27	1906 x (1±15%)
24	18.0	1.20	36	3390 x (1±15%)
48 ⁴⁾	36.0	2.40	72	10600 x (1±15%)
60 ⁴⁾	45.0	3.00	90	16600 x (1±15%)

- Notes: 1) When require pick-up voltage ≤ 70% nominal voltage, special order allowed .
 2) The data shown above are initial values.
 3) Maximum voltage refers to the maximum voltage which relay coil could endure in a short period of time.
 4) For products with rated voltage ≥ 48V, measures should be taken to prevent coil overvoltage in order to protect coil in test and application (eg. Connect diodes in parallel).

SAFETY APPROVAL RATINGS

UL/CUL	6A 30VDC at 85°C
	6A 277VAC at 85°C
	R300 B300
VDE	6A 30VDC at 85°C 6A 250VAC at 85°C

- Notes: 1) All values unspecified are at room temperature.
 2) Only typical loads are listed above. Other load specifications can be available upon request.



HONGFA RELAY

ISO9001, ISO/TS16949, ISO14001, OHSAS18001, IECQ QC 080000 CERTIFIED

2018 Rev. 1.00

ORDERING INFORMATION

Type	HF41F / 12 -H 8 S T G (XXX)					
Coil voltage	5, 6, 9, 12, 18, 24, 48, 60VDC					
Contact arrangement	H: 1 Form A		Z: 1 Form C			
Version ¹⁾	8: Flat pack version		Nil: Vertical version			
Construction ²⁾³⁾	S: Plastic sealed		Nil: Flux proofed			
Contact material	T: AgSnO ₂		Nil: AgNi			
Contact plating ⁴⁾	G: Gold plated		Nil: No gold plated			
Special code ⁵⁾	XXX: Customer special requirement		Nil: Standard			

Notes: 1) We recommend flux proofed types for the flat pack version.

2) We recommend flux proofed types for a clean environment (free from contaminations like H₂S, SO₂, NO₂, dust, etc.).

We suggest to choose plastic sealed types and validate it in real application for an unclean environment (with contaminations like H₂S, SO₂, NO₂, dust, etc.).

3) Contact is recommended for suitable condition and specifications if water cleaning or surface process is involved in assembling relays on PCB.

4) For gold plated type, the min. switching current and min. switching voltage is 10mA 5VDC.

5) The customer special requirement express as special code after evaluating by Hongfa. e.g. (210) stands for pick-up voltage less than 70% of nominal voltage. e.g. (414) stands for wide coil pin type.

OUTLINE DIMENSIONS, WIRING DIAGRAM AND PC BOARD LAYOUT

Unit: mm

Outline Dimensions

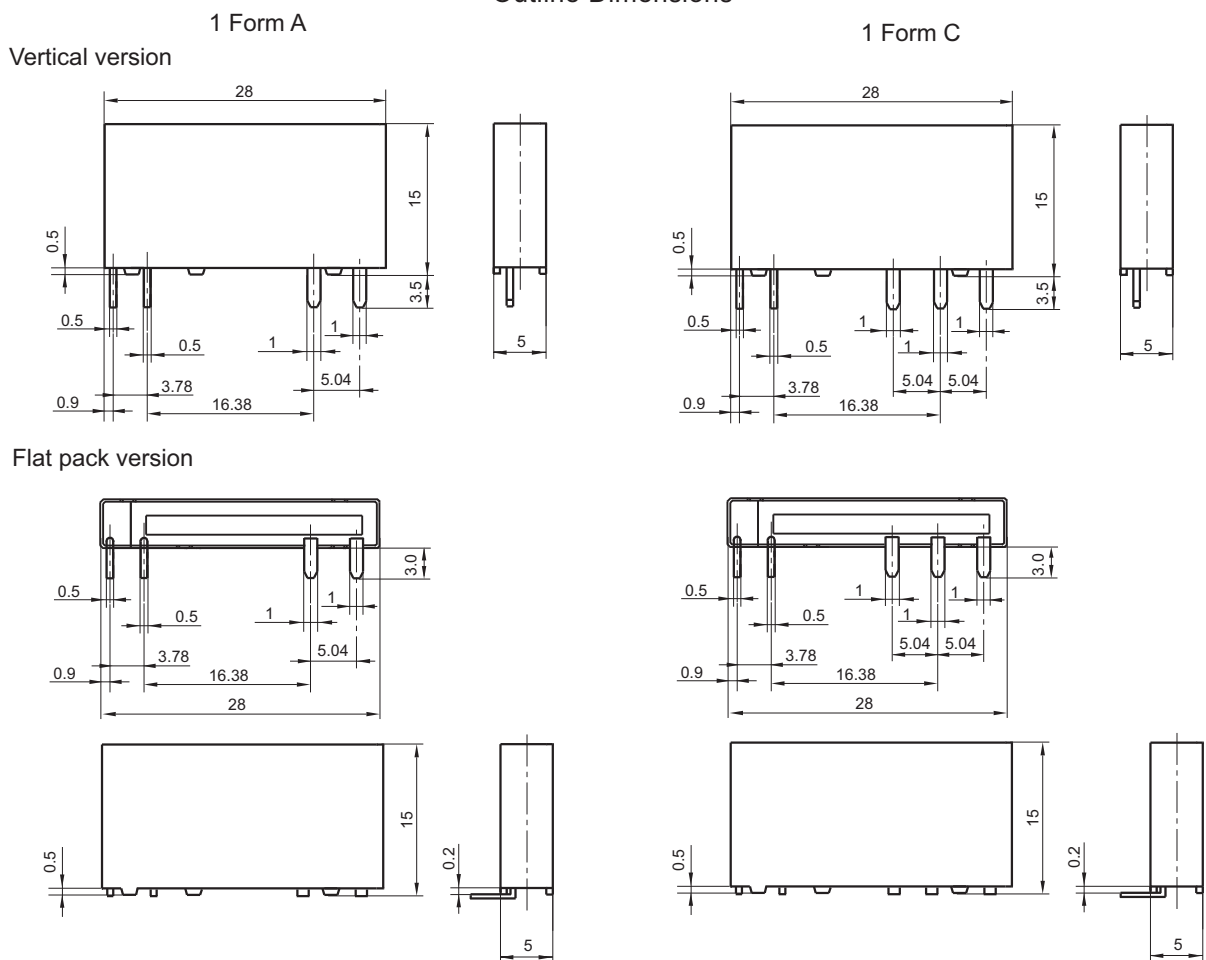

OUTLINE DIMENSIONS, WIRING DIAGRAM AND PC BOARD LAYOUT

Unit: mm

Outline Dimensions

1 Form A
Special code: (414)

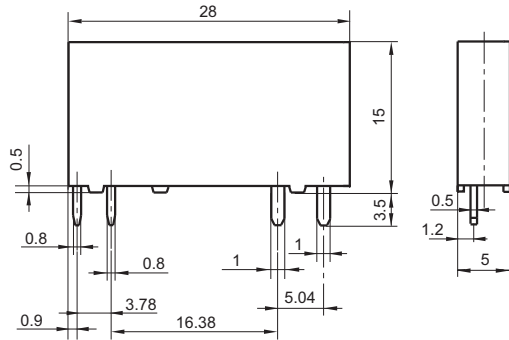

1 Form C

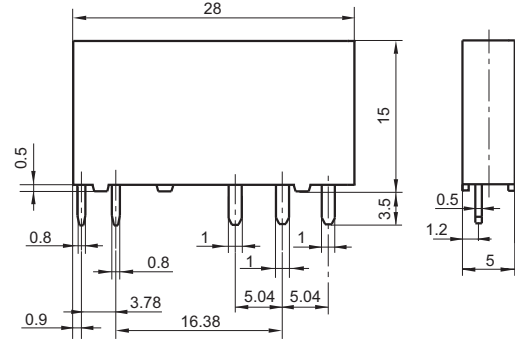

PCB Layout (Bottom view)

1 Form A

Vertical version

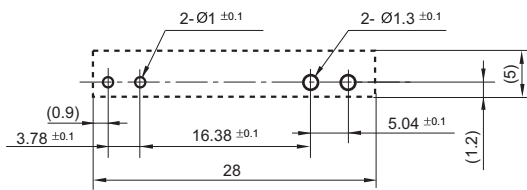

1 Form C

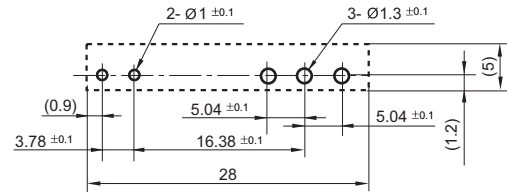

Flat pack version

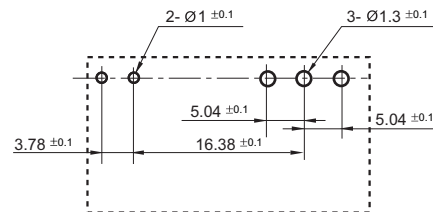
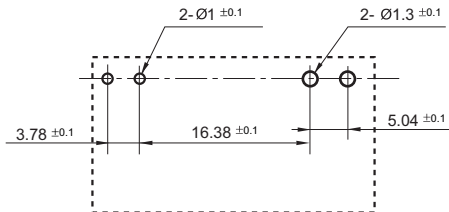

Special code: (414)

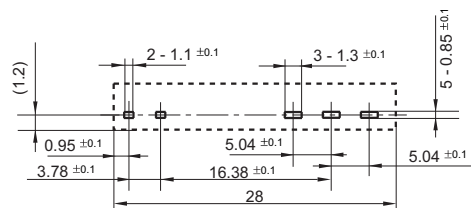
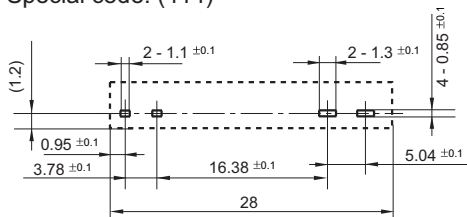

Wiring Diagram (Bottom view)

1 Form A

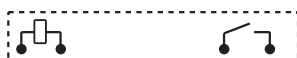

1 Form C



- Remark: 1) In case of no tolerance shown in outline dimension: outline dimension $\leq 1\text{mm}$, tolerance should be $\pm 0.2\text{mm}$; outline dimension $> 1\text{mm}$ and $\leq 5\text{mm}$, tolerance should be $\pm 0.3\text{mm}$; outline dimension $> 5\text{mm}$, tolerance should be $\pm 0.4\text{mm}$.
2) The tolerance without indicating for PCB layouts is always $\pm 0.1\text{mm}$.

CHARACTERISTIC CURVES

MAXIMUM SWITCHING POWER

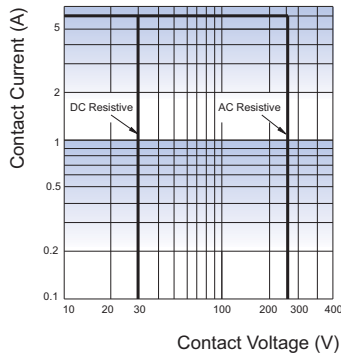

ENDURANCE CURVE

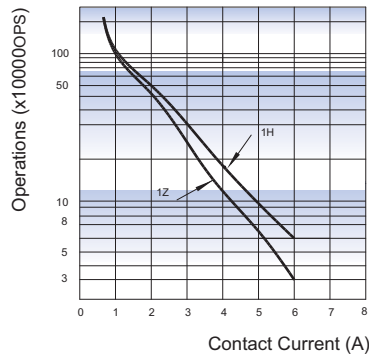

Test conditions:
NO, AgNi, Resistive load, 250VAC,
Flux proofed, Room temp., 1s on 9s off.

COIL TEMPERATURE RISE

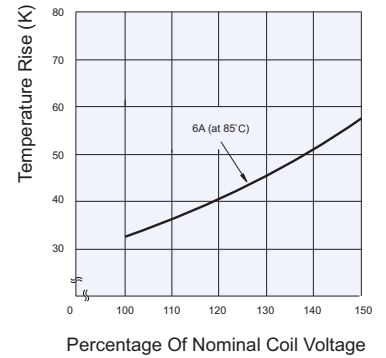

Test conditions:
6A 85°C
(Typical curve of 24VDC standard type)

Disclaimer

The specification is for reference only. See to "Terminology and Guidelines" for more information. Specifications subject to change without notice. We could not evaluate all the performance and all the parameters for every possible application. Thus the user should be in a right position to choose the suitable product for their own application. If there is any query, please contact Hongfa for the technical service. However, it is the user's responsibility to determine which product should be used only.